

SMOOTH
SURFACE

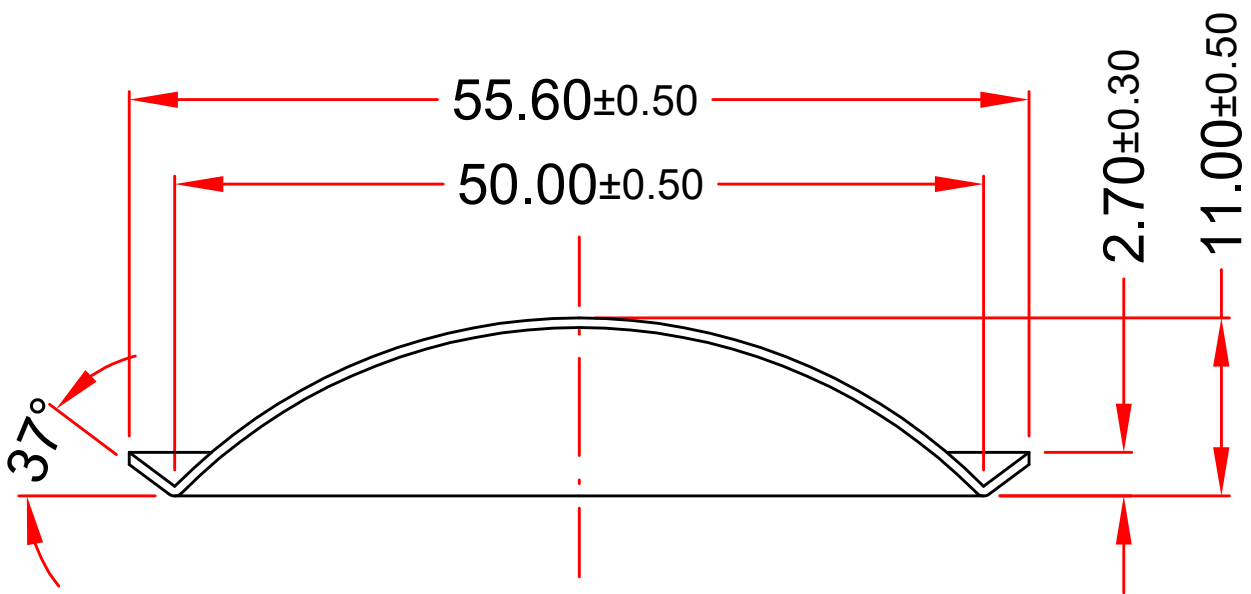
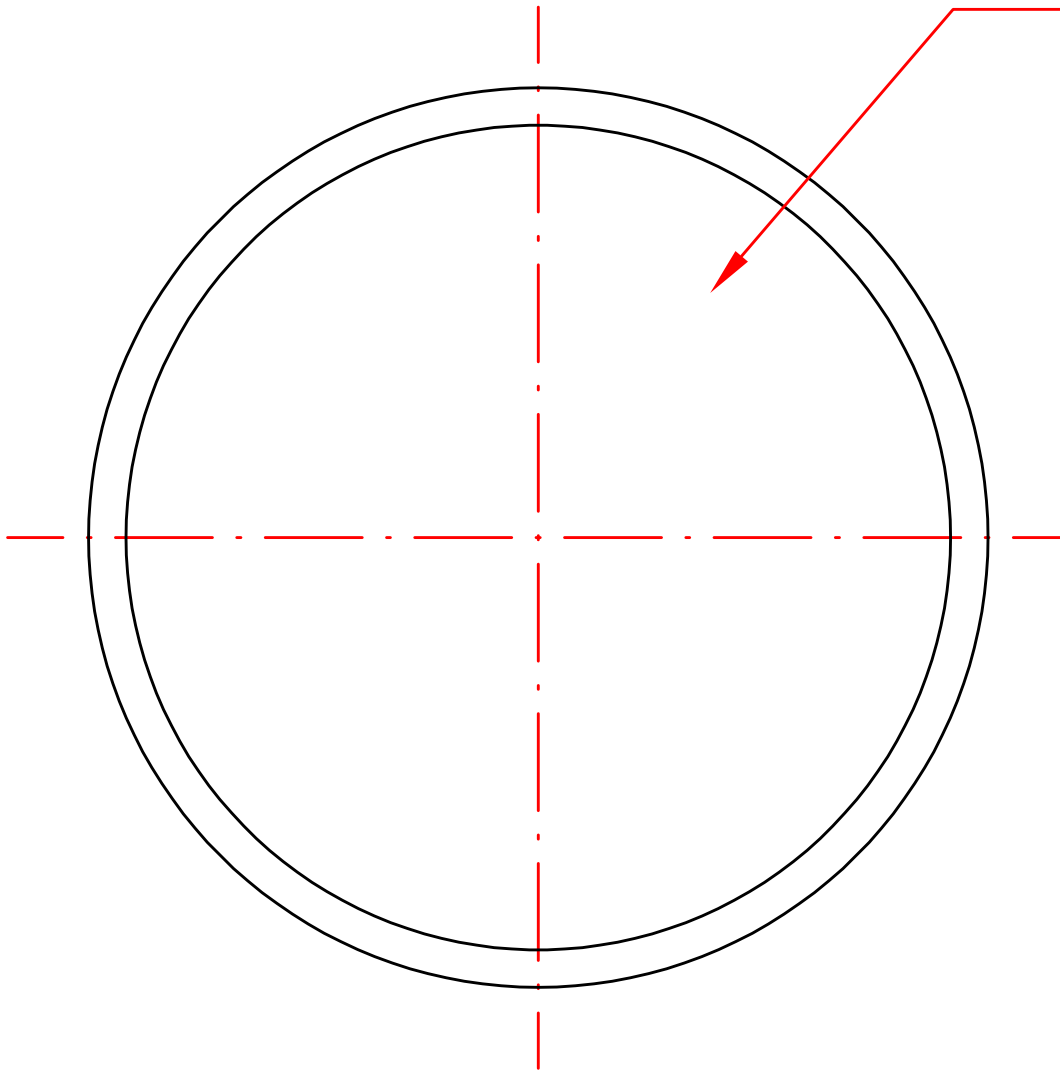

DC-055-15