

SMOOTH SURFACE

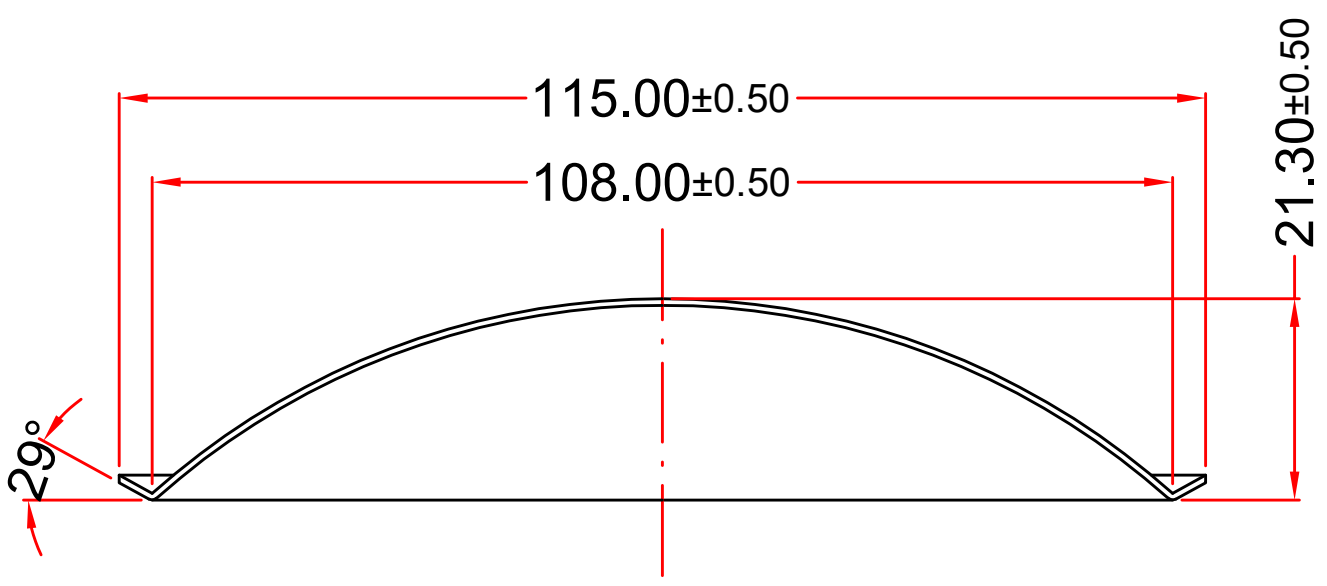

DC-115-12