

SMOOTH
SURFACE

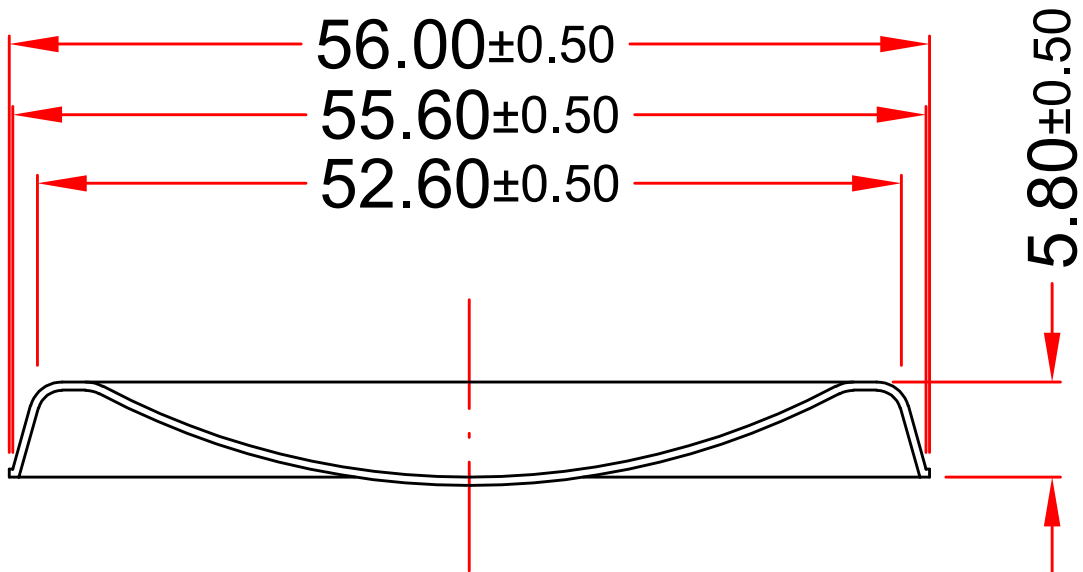
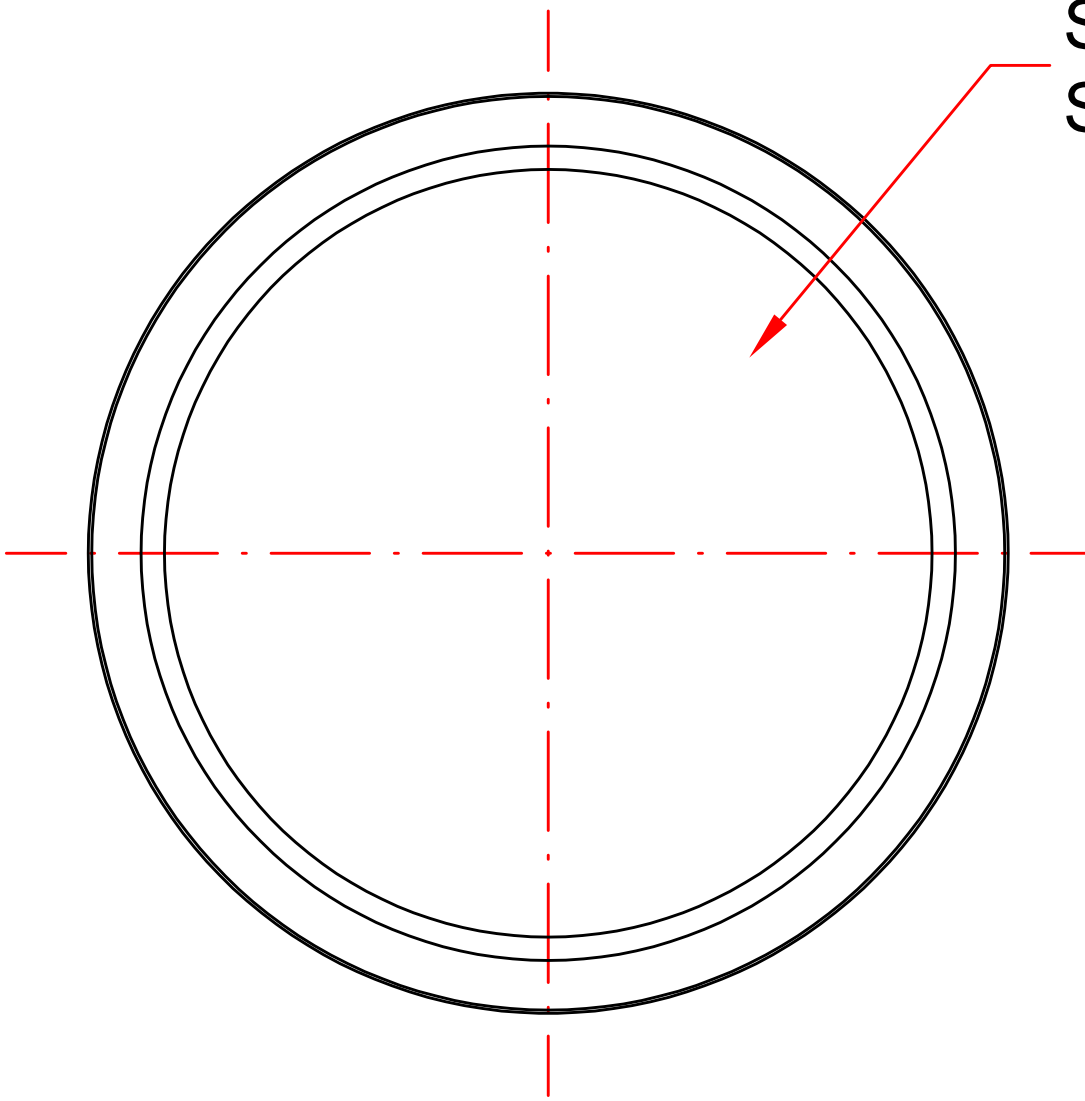

DC-056-01